



# SPパッキン 施工設計資料

- 建築概要  
 ●集合住宅  
 ●鉄筋コンクリート構造  
 ●内壁下地材 フクビSPパッキン工法 (SW工法A+C)



## 和室・押入詳細

平面図

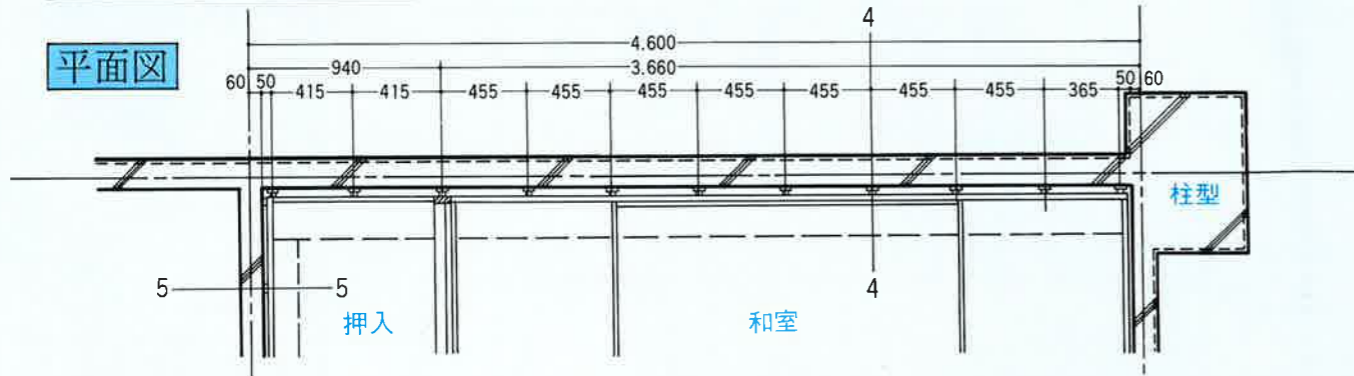

展開図

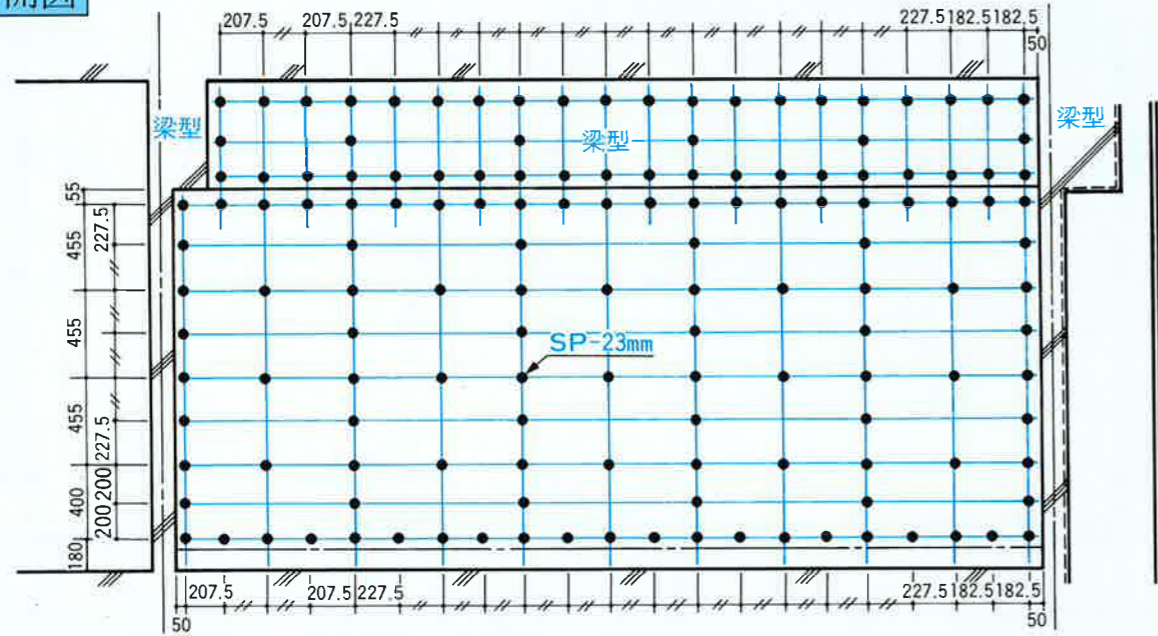

4-4 断面図

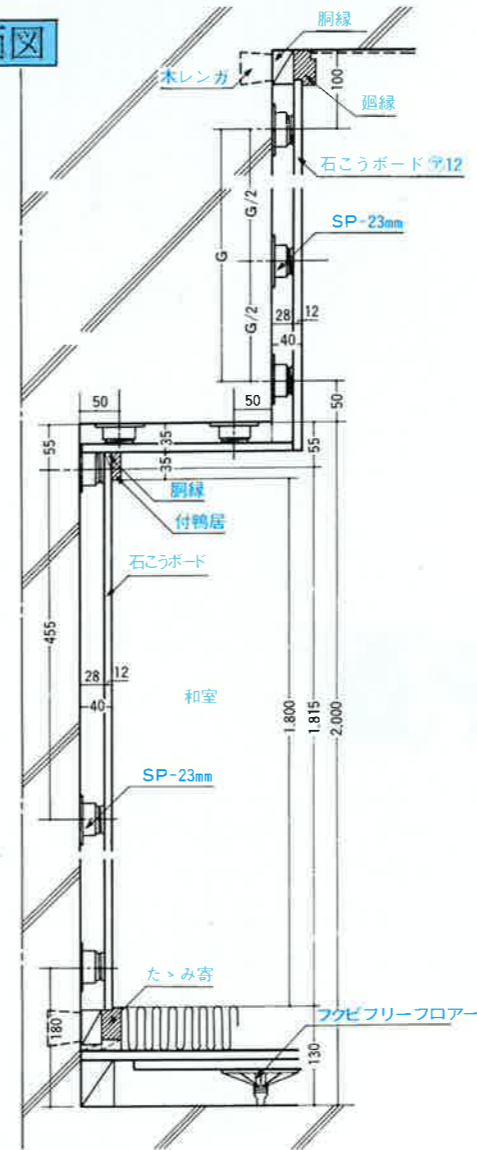

5-5 断面図

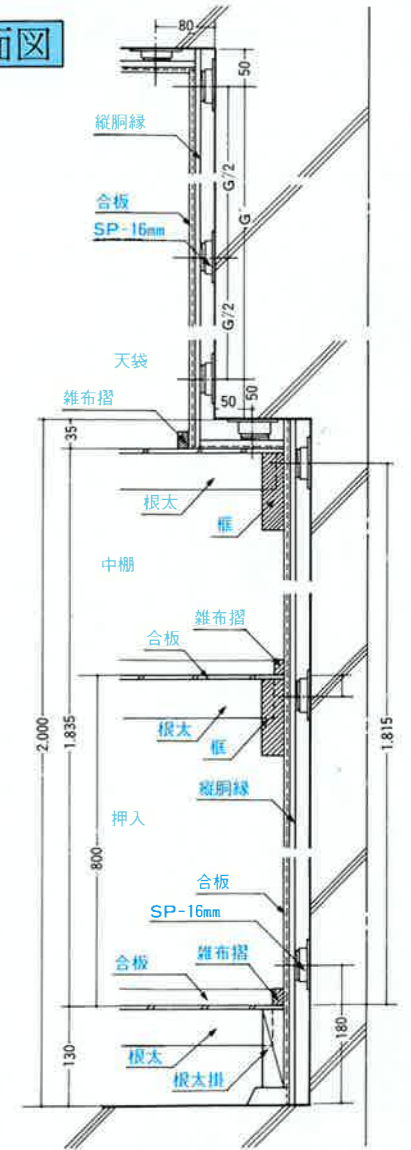

## 台所・食事室詳細

平面図

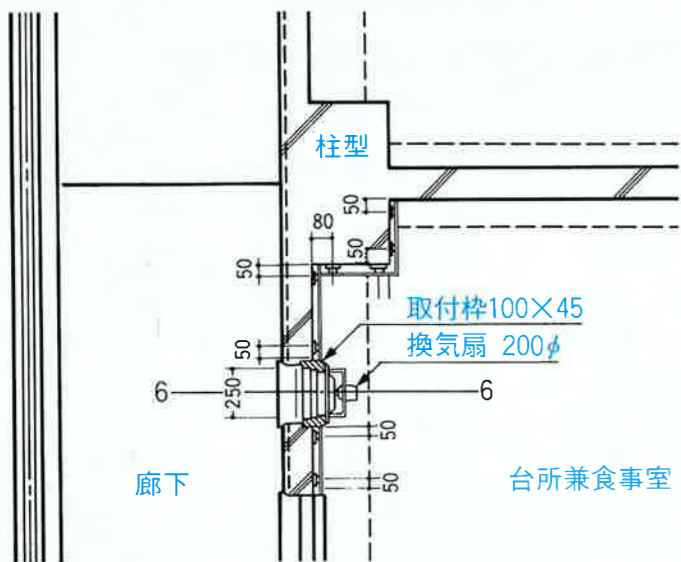

SP割付展開図

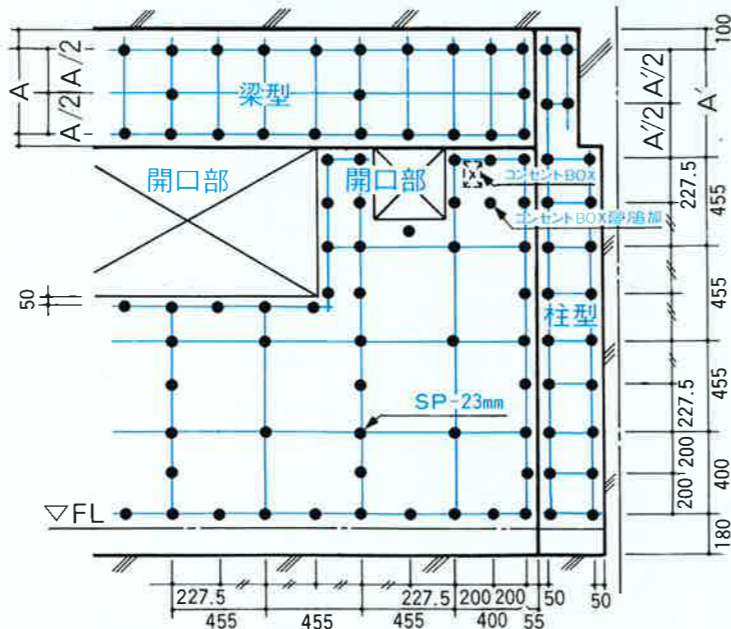

平面詳細図

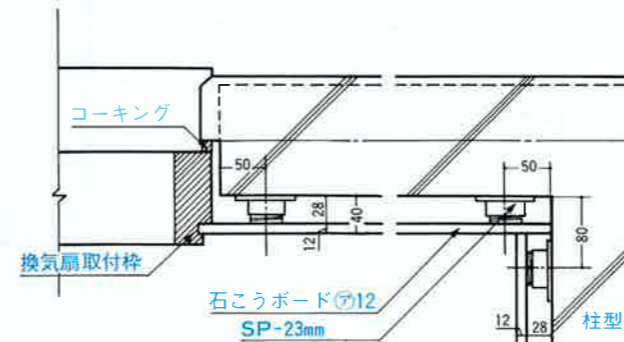

6-6 断面図

